

- Large Current and Low DCR
- Magnetically shielded construction
- ROHS Compliance Product
- Operating Temperature range: 0°C TO +85°C



Electrical Specifications @ 25°C

P/N	OCL @100KHz, 0.1V	DCR	RATED CURRENT
MD67R0-2.0	(1-2)	(1-2)	(1-2)
	67μH ±20%	140mΩ MAX	2.0A MAX

DIMENSIONS (unit: inch/mm):

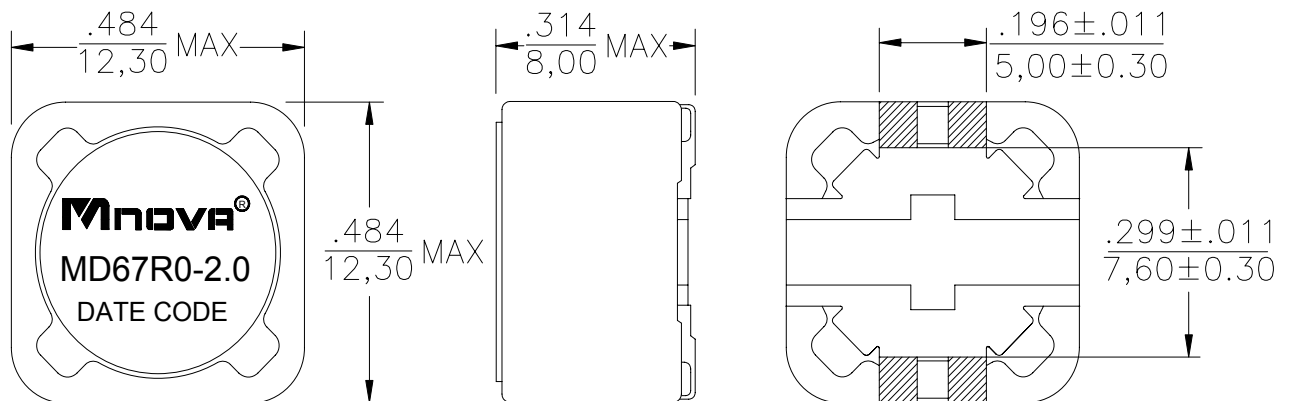

SCHEMATICS:

