

- Large Current and Low DCR
- Magnetically shielded construction
- ROHS Compliance Product
- Operating Temperature range: 0°C TO +85°C



Electrical Specifications @ 25°C

P/N	OCL @100KHz, 0.1V	DCR	RATED CURRENT
MD22R0-3.6	(1-2)	(1-2)	(1-2)
	22μH ±20%	43mΩ MAX	3.6A MAX

DIMENSIONS (unit: inch/mm):

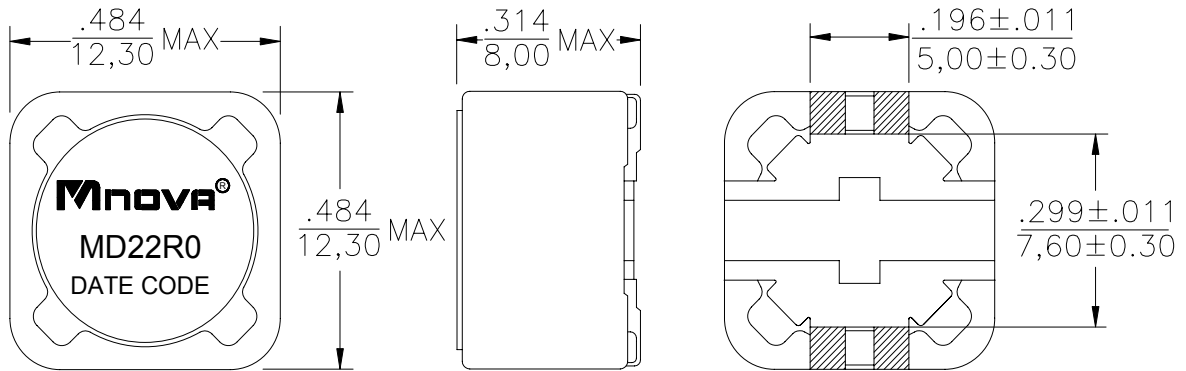

SCHEMATICS:

